

## MACH 5 WAY



## Technical Features

- Luminaires for high pressure mercury vapour lamp, high pressure sodium lamp or metal halide lamp.
- Housing of die-cast aluminium alloy, painted electrostatically in silver colour. Application of a protection coating aimed at ensuring excellent resistance to corrosion.
- Reflector made of anodized high purity aluminium (99,8%). Output ratio type cut-off.
- Porcelain lampholder.
- Gaskets made of anti-age weather resistant silicon rubber.
- Tempered glass suitable for high temperature, thermal shocks and crashes (6J).
- Connection to power supply via a cable gland PG13,5 – IP68.
- Teflon filter for decompressing the luminaire.
- Gear tray of galvanized steel for Class I or of a special selfextinguished thermoplastic material for Class II.
- For Class II electrical safety switch disconnects the main power supply on opening the luminaire in maintenance.
- Bracket made of galvanized painted steel with index for vertical orientation.
- Fixture installable directly on Ømax.60mm pole, with aluminium coated accessories suitable for the single or double assembly, and the single wall assembly.
- Wind exposed surface = 0,09 m<sup>2</sup> ( with vertical addressing 0°).
- The luminaire are in accordance with regulations EN 60598-1 & EN 60598-2-3.
- Connection for operation on 230V-50Hz with conventional control gear and power factor correction capacitor.

**MACH 5 WAY**

**MACH 5 WAY**



|                            |   |                                  |                              |
|----------------------------|---|----------------------------------|------------------------------|
| CE                         | F                                       | IP 66                            |                              |
| HME                        | HST                                     | HIT-CE                           | HSE                          |
| OSRAM: HGL<br>PHILIPS: HPL | OSRAM: NAV-T<br>PHILIPS: SON-T          | OSRAM: HCS-TT<br>PHILIPS: COM-TT | OSRAM: NAV-E<br>PHILIPS: SON |
| HIT                        | OSRAM: HQI-T/NSI<br>PHILIPS: HPI-T PLUS |                                  |                              |

- Output ratio type cut-off. Optic group with thermal toughened flat glass. Wind exposed surface: 0,0870m<sup>2</sup>.

| Code  | Description  |
|---|--|
| <b>For high pressure mercury vapour lamp</b>                          |  |
| 727022  | 1x125W HME / E27                                   |
| 727032  | 1x250W HME / E40                                   |
| <b>For high pressure sodium lamp</b>                                  |  |
| 727072  | 1x 70W HST or HSE / E27                            |
| 727082  | 1x100W HST or HSE / E40                            |
| 727092  | 1x150W HST or HSE / E40                            |
| 727102  | 1x250W HST or HSE / E40                            |
| 727112  | 1x400W HST / E40                                   |
| 727152  | 1x150/100W HST or HSE / E40 with two-level dimming |
| 727132  | 1x250/150W HST or HSE / E40 with two-level dimming |
| 727142  | 1x400/250W HST / E40 with two-level dimming        |
| <b>For metal halide lamp</b>  |  |
| 727072  | 1x 70W HIT-CE / E27                                |
| 727082  | 1x100W HIT-CE / E40                                |
| 727092  | 1x150W HIT-CE / E40                                |
| 727042  | 1x250P HIT* / E40                                  |
| 727062  | 1x400P HIT* / E40                                  |
| * HIT 250-400W: OSRAM HQI-T/NSI, PHILIPS HPI-T PLUS, SYLVANIA HSI-THX |  |

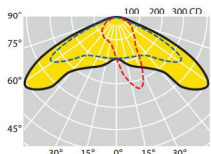
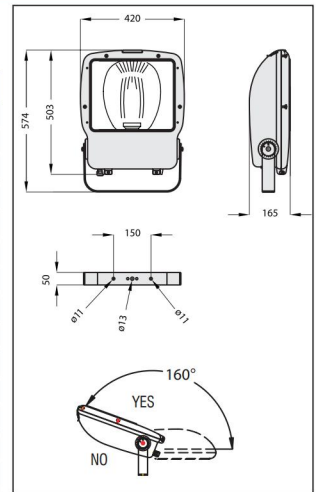

250W HST / E 40  
POS. A C max=15°

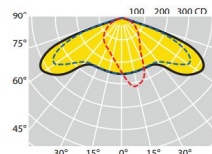
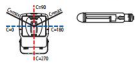

400W HST / E 40  
POS. A C max=5°

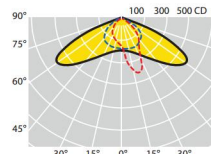
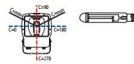

150W HST / E 40  
POS. A C max=30°

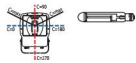

Note: The preceding luminaires are also available in **class II**.

**MACH 5 WAY - ACCESSORIES**

**AKRON 1**



|  |  |  |  |
|--|--|--|--|
|  |  |  |  |
|--|--|--|--|

- Single top pole mounting support in die-cast aluminium block Ø 60mm.

| Code   | Description   |
|--------|---------------|
| 702302 | AKRON 1 60235 |

**AKRON 2**



|  |  |  |  |
|--|--|--|--|
|  |  |  |  |
|--|--|--|--|

- Double top pole mounting support in die-cast aluminium block Ø 60mm.

| Code   | Description   |
|--------|---------------|
| 702303 | AKRON 2 60237 |

**AKRON 3**



|  |  |  |  |
|--|--|--|--|
|  |  |  |  |
|--|--|--|--|

- Wall mounting single support in die-cast aluminium.

| Code   | Description   |
|--------|---------------|
| 702304 | AKRON 3 60238 |